



Mechanical Technical Assistance
Manual for washers
HS-6008 / EH020
MS-610 / EM025

GIRBAU, S.A.
Ctra de Manlleu, km. 1
08500 VIC (Barcelona) • SPAIN
Tel. 34 93 8861100
Fax 34 93 8860785
girbau@girbau.es
www.girbau.com

SERVICE

HS-6008 / EH020
MS-610 / EM025

For USA & CANADA:

CONTINENTAL GIRBAU Inc.
2500 State Road 44
WI 54904 Oshkosh • USA
Tel. 1(920) 231-8222
Fax 1(920) 231-4666
info@continentalgirbau.com
www.continentalgirbau.com

SAFETY INSTRUCTIONS

**WARNING ;****INSPECTION ROUTINES, MAINTENANCE OR REPAIR**

- The actions described in these instructions are strictly reserved for Service Technicians who have been authorized by the manufacturer. Any actions carried out by personnel who are unauthorized by the manufacturer will be considered to be improper and will result in the automatic void of washer's warranty.
- The manufacturer will not accept responsibility for any physical and/or material damage caused by actions taken by unauthorized personnel.
- Compliance with the safety warnings listed in the Installation Manual is obligatory; check them before. Read them before servicing the washer.
- Avoid carrying out any course of action on the machine without having first carefully read the washer's installation and operating manuals, paying special attention to the safety instructions.
- Making inspections, maintenance or repairs without taking safety measures or having the necessary technical competence can cause **ELECTRICAL SHOCK OR SERIOUS ACCIDENTS**.
- **COMPLETELY** disconnect the machine from the original power source and check for accidental reconnection.
- Disconnect the electrical connection from the external dosing to the washer. These circuits are independent of the supply to the washer.
- Moving the **ON switch** to the OFF position is not sufficient
- Wait a minimum of (5) five minutes after disconnection to ensure the elimination of residual voltage within the machine.
- Close and mechanically interlock the water supply valves and check that machine has **COMPLETELY** drained, parts have cooled down and that no pieces are in movement through inertia

INDEX**SAFETY INSTRUCTIONS**

1. Preparation
 - 1.1. Required tools.
 - 1.2. Parts and materials.
 - 1.3. Parts.
 - 1.4. Emptying the residual bath.

2. Disassembly
 - 2.1. Disassembling the covers
 - 2.2. Disassembling the front panel of the washing machine
 - 2.3. Disassembling the outer drum front
 - 2.4. Disassembling the drum.
 - 2.5. Disassembling the bearing box.

3. Bearing box
 - 3.1. Disassembling the bearings
 - 3.2. Changing the bearings

4. Back of the outer drum
 - 4.1. Cleaning the back of the outer drum
 - 4.2. Removing the watertight assembly.
 - 4.3. Changing the radial seal.
 - 4.4. Changing the V-ring plate.
 - 4.5. Mounting the outer drum separator.

5. Assembling
 - 5.1. Assembling the bearings' box
 - 5.2. Changing the ring seal.
 - 5.3. Assembling the drum.
 - 5.4. Assembling the front panel of the washing machine.
 - 5.5. Assembling the covers

6. Final checking
 - 6.1. Checking the machine.

1. PREPARATION

1.1. Required tools.

DISASSEMBLY ASSEMBLY	TOOLS
Lower front and rear covers	TORX 20 screwdriver TORX 25 screwdriver
Front panel of the washing machine	Key for opening the top cover, supplied with the machine. 22mm (7/8 inch.) wrench
Front outer drum	Two open wrench 13mm. (9/16 inch.). Lock grip pressure-type pliers.
Inner drum	17mm (11/16 inch.) wrench. Two 3/4" adjustable spanners
Bearings' box	13mm tube wrench Two wrench 13mm. (9/16 inch.).
Bearings	Nylon-headed hammer (approx. recommended weight: 2kg)
Back of the outer drum	13mm (9/16 inch.) wrench
Seals ring	19 mm (3/4 inch.) wrench 6 mm. Allen wrench

TOOLS DESCRIPTION	TOOLS	CODE
Front bearing inserter	A	433284
Front bearing inserter	B	433334
Bearing end-piece	C	433300
Front bearing extractor.	D	433342
Handle for bearing inserter and extractor.	E	433326
Radial seal inserter.	F	433359
Drum inserter	G	433367
Drum extractor	H	433433
Extractor for ring seals	X	438390
Inserter for ring seals.	Y	438614

1.2. Pieces and materials

For identifying the pieces, consult their position in the figures in section 1.3.

DESCRIPTION	POSITION	QUANTITY
Toric gasket Ø40xØ4 4x2	12	2
Seal ring	28	1
Ring Vring 50.	10	1
Vring plate	31	1
joint	32	1
Seal Ø52xØ68x8 BA.	11	1
Bearing 6208	13	1
Bearing 6206	14	1
SHELL alvania 3 grease		50 gr. (approx)
Silicone		Any kind of non-acid sealing silicon can be used. It is important to use a fine opening applicator.

1.3. Parts list

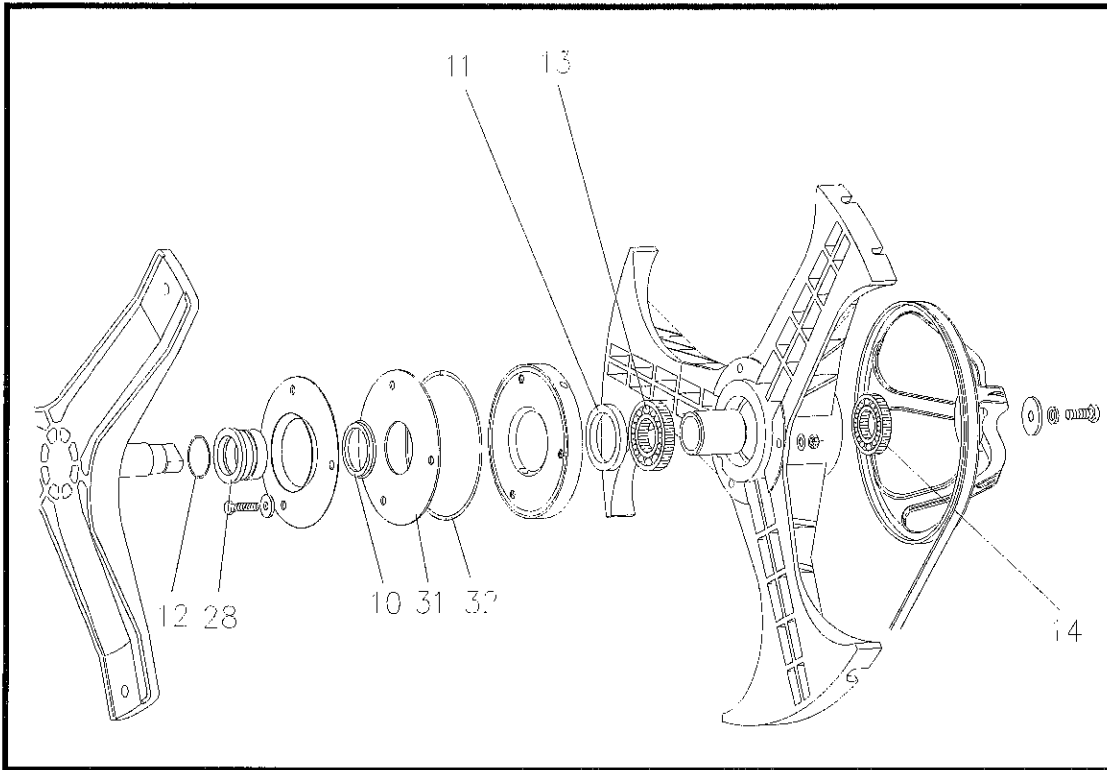

NOTE

The numbers on the drawing above correspond to those from machines parts list HS-6008 / EH020.

The system for bearing replacement is the same regardless of any differences there may be between the different machine models HS / EH and MS / EM.

1.4. Emptying the residual bath (machines with pump drain)

Before acting upon the washing machine:

- Situate the outer, horizontal drainpipe tube onto the floor and place a recipient under it for collecting the water that can come out.
- Lightly tilt the machine forwards and backwards in order to help empty the residual water that remains at the bottom of the outer drum and in the drains

2. DISASSEMBLY

2.1. Disassembling the covers

- Rear central cover. Take out the fastening screws, move the cover upwards and separate it from the machine (*fig. 1*).

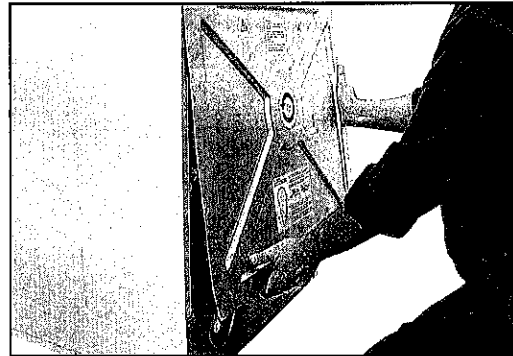

fig. 1

- Lower front cover. Unscrew the three fastening screws at the base and separate it from the machine (*fig. 2*).

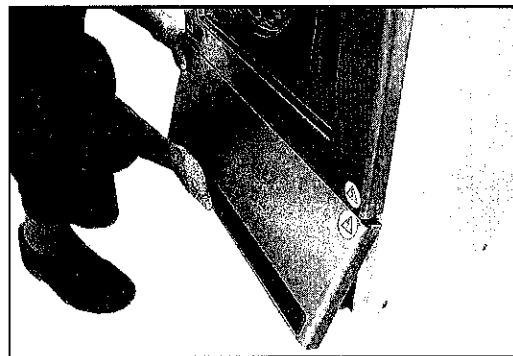

fig. 2

2.2. Disassembling the front panel of the washing machine.

- Open the door of the washing machine
- With the help of a screwdriver, remove the spring clamp that fastens the door gasket. Separate the front panel from the washing machine (*fig. 3*).

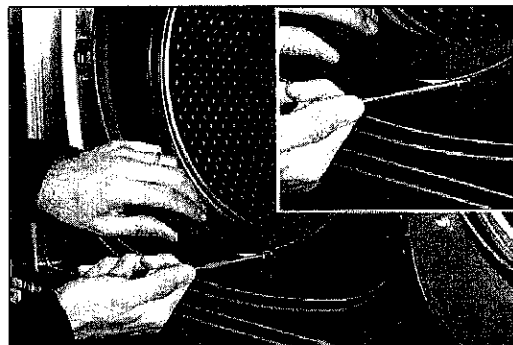

fig. 3

- Take the fastening screws out of the door lock device (*fig. 4*). Separate it from the front panel.



fig. 4

- Open the top cover lock and remove the top cover.
- Open the control panel of the washing machine using the wrench 22mm (7/8 inch.). (fig. 5).

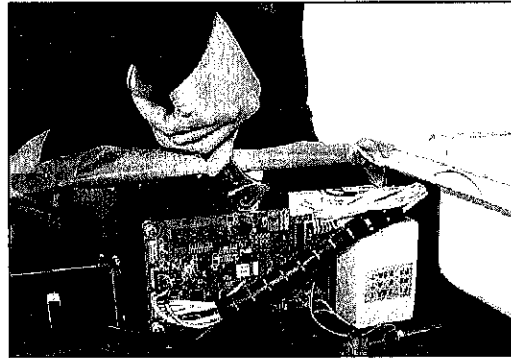

fig.5

- Take out the four Torx screws that fasten the front panel of the washing machine and remove it from the machine. The location of the screws is indicated by means of the arrows in (fig. 6).
- The top screws are located inside the front panel.

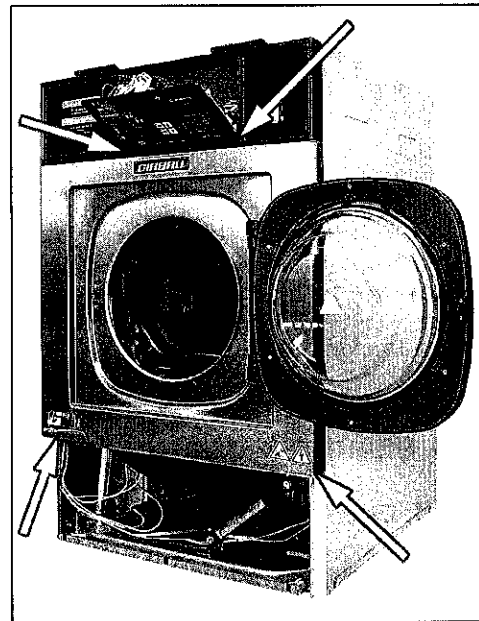

fig.6

2.3. Disassembling the outer drum front.

- Take out the joint screw of the fastening ring of the front panel (figure 7). Remove the ring.
- Hold the front panel and remove the union gasket
- Remove the outer drum front panel.

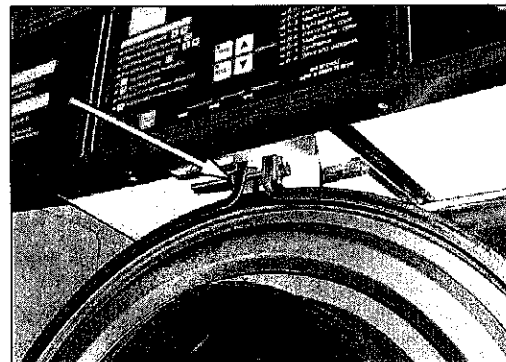

fig.7

2.4. Disassembling the drum.

- (It is advisable to have this operation performed by two people)
- Remove the drum pulley belt.
- Take the fastening screw out of the drum pulley. Remove the pulley from the shaft.
- Fix H tool, to protect the shaft with the protector which accompanies tool H and screw with the help of a wrench to push the drum forward. (fig. 8).
- Once the shaft is free from the bearings, take the drum out of the inside of the outer drum. Avoid rubbing the shaft with the back of the outer drum.

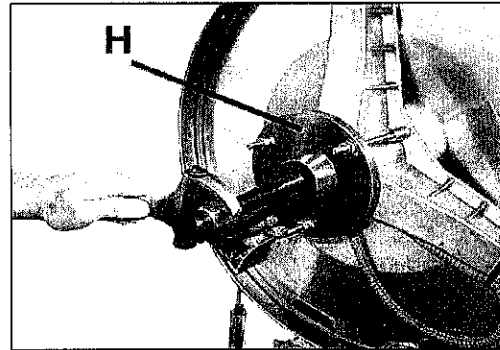

fig.8

2.5. Disassembling the bearings' box.

- Note down the position of the level sensor tube in order to put it back during assembly.
- Note down the position of the screws and washers in order to put them back during assembly.
- Take out the L screws (fig. 9) fastening the bearings' box to the back of the outer drum.
- Take out the M screws (fig. 9) fastening the bearings' box to the outer drum.
- Remove the bearings' box.

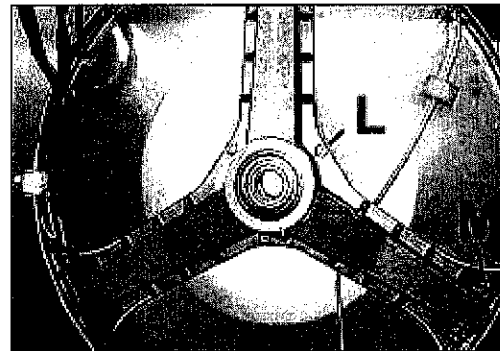

fig.9

3. BEARINGS' BOX**3.1. Disassembling the bearings.**

- Position the bearings' box in a way that the rear bearing can be separated from the box.
- Remove the rear bearing and the bearing end-piece by tapping from the inside of the bearing box with the help of tools C and E. (fig. 10).

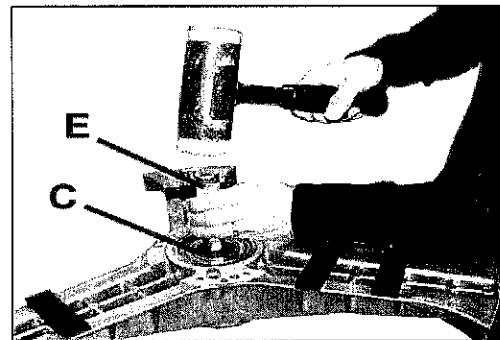

fig. 10

- Rotate and position the bearings' box in a way that the front bearing can be separated from the box.
- Remove the front bearing by tapping from the inside of the bearing box (fig. 11) with the help of tools D and E.

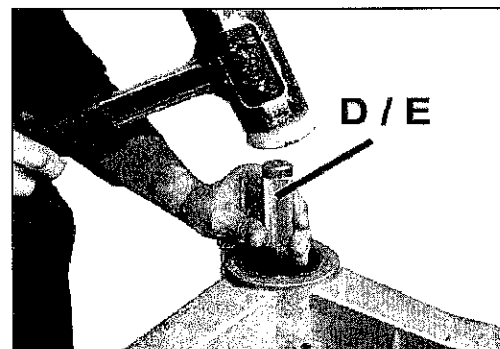

fig.11

3.2. Changing the bearings.

- Clean the bearings' box, especially the area housing the bearings.
- Lightly lubricate the bearing housing to make it easier to mount.
- Lean the conical trunk end of the bearings' box on a hard, clean and flat surface.
- Position the front bearing in its housing (the numbered side of the bearing in the external part). Introduce it up to the end of the box using the **B** tool (fig. 12).

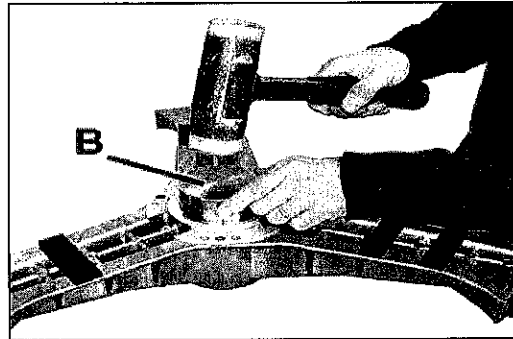

fig.12

- Turn the bearings' box around and position it over the **B** centring tool used in the previous step to mount the bearing. (fig. 13).

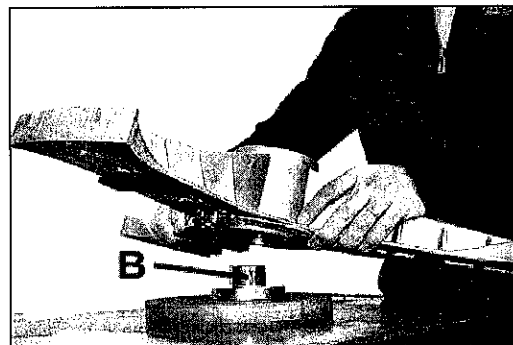

fig.13

- Introduce the bearings' end-piece into the bearings' box and position it over the **B** centring tool. The conical side facing outward (fig. 14).

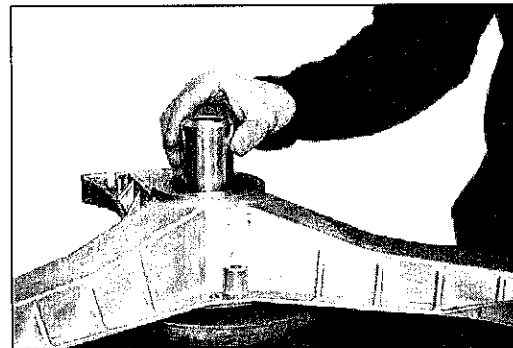

fig. 14

- Position the rear bearing in its housing (the numbered side of the bearing in the external part). Introduce it up to the end of the separator using **A** & **E** tools (fig. 15).
- Check that the bearings' end piece is pressed between the two bearings.

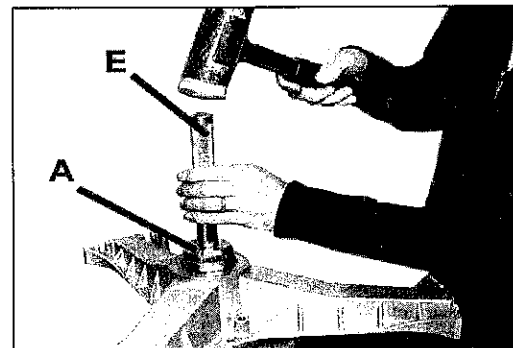

fig. 15

4. BACK OF THE OUTER DRUM

4.1. Cleaning the back of the outer drum

- This procedure should be carried out if the watertight seal is not to be changed.
- Check the back of the outer drum in the friction area of the seal. This surface should be clean and should not display dents, scratches or deformations for proper tightness
- Use a damp cloth for eliminating remains of detergent or fabric (*fig. 16*).
- The adherence of remains of rubber can be cleaned with solvent.
- The adherence of lime can be cleaned with an anti-lime liquid and then wiped away with a damp cloth.

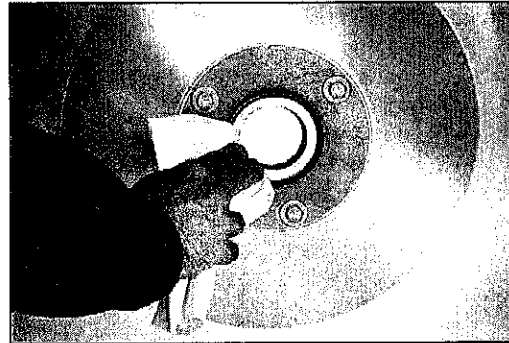

fig. 16

4.2. Removing the watertight assembly

- Loosen the three screws from the inside of the outer drum whilst another person holds the outer drum separator secure from outside the back of the machine. (*fig. 17*).
- Remove the outer drum separator from outside the back of the machine and the V-ring protection cover from the inside of the outer drum.

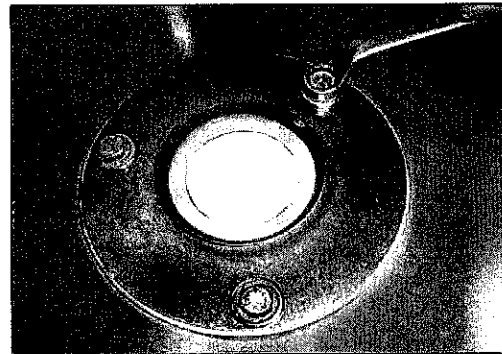

fig. 17

4.3. Changing the radial seal.

- Rest the outer drum separator on a flat, hard, clean surface.
- Remove the old seal from its housing.
- Position the new radial seal on top of the outer drum separator (the seal spring facing outwards). Insert the seal completely using tool F (*fig. 18*).
- Spread a little grease where the spring is on the inside of the radial seal.

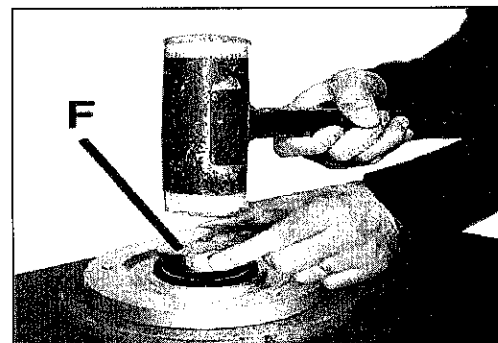

fig. 18

- Turn the separator.
- Remove the old flexible joint.
- Clean the surface well and spread a fine strip of silicone on the joint housing, replace the new flexible joint on the outer drum separator. (fig. 19).

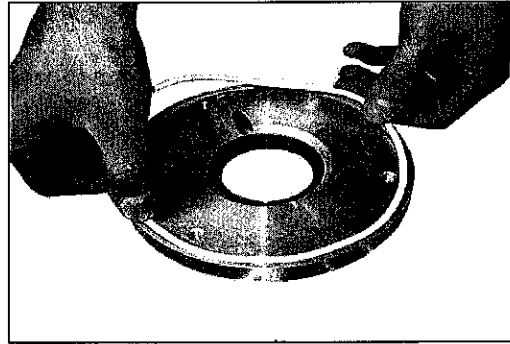

fig. 19

4.4. Changing the V-ring plate

- Separate the deflector from the outer drum ring seal.
- Separate the V-ring plate from the outer drum.
- Apply a fine strip of silicone around the outside edge of the new V-ring plate. (fig. 20).
- Place the ring seal deflector on top of the plate making sure the three holes are lined up and pressing firmly on the silicone.

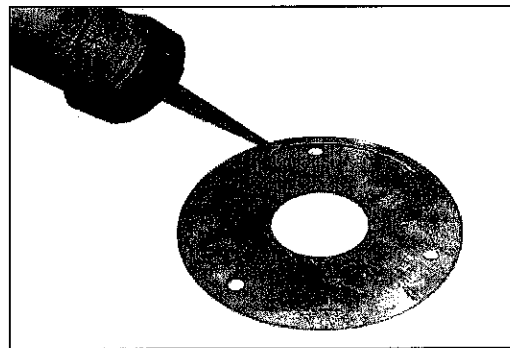

fig. 20

- Place the combined ring seal deflector and V-ring plate on the back of the outer drum.
- The deflector notch must match up to the vertical welded joint on the outer drum as indicated by the arrow. (fig. 21).

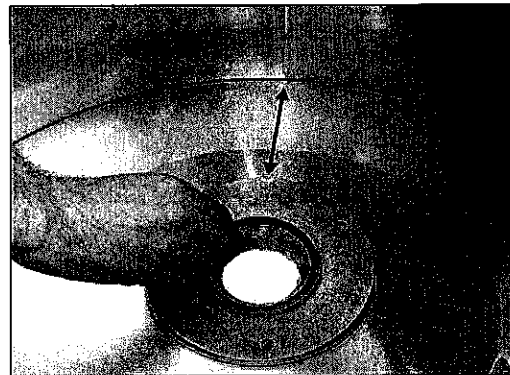

fig. 21

- Position the outer drum separator as indicated in (fig. 23) and secure in place. Put the three M8x55mm bolts in place from the inside of the outer drum and apply silicone to the middle of the thread on each. (fig. 22).

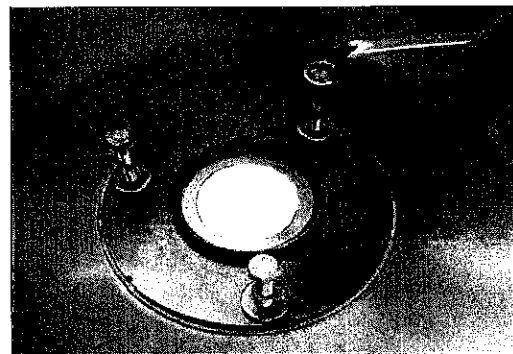

fig. 22

4.5. Mounting the outer drum separator

- Keep the outer drum separator fixed as shown in (fig. 23).
- Remember that drain position is the bottom of the outer drum.
- Make sure the bolts are firmly tightened from the inside of the outer drum using the 13mm wrench. (9/16 inch.) (fig. 22).

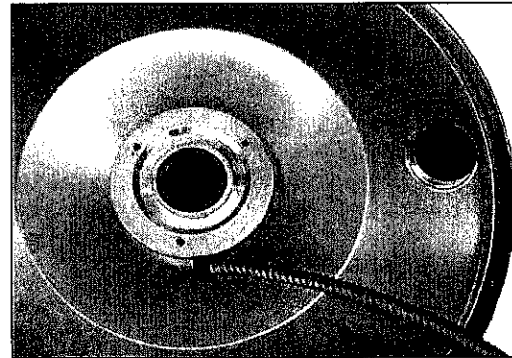

fig. 23

5. Assembling

5.1. Assembling the bearings' box.

- Position the bearings' box against the rear side of the back of the outer drum, trying to coincide with the fastening points. The position of hole **N** (fig. 24) relates to the position of the drainage hole on the outer drum separator (care must be taken not to damage the drainage tube).

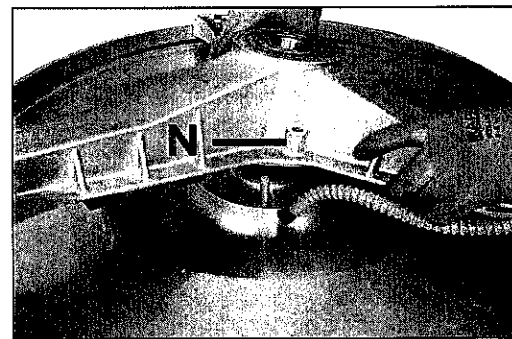

fig. 24

- Fasten the center of the bearings' box to the center of the back of the outer drum by means of the **L** screws and the corresponding washers (fig. 25). Do not tighten.
- Fasten the ends of the bearings' box to the edge of the outer drum by means of the **M** screws and the corresponding nuts and washers (fig. 25).
- Avoid letting the level sensor tube become pressed by the bearings' box.
- Tighten the central fastening screws **L** first and then the peripheral ones **M**.

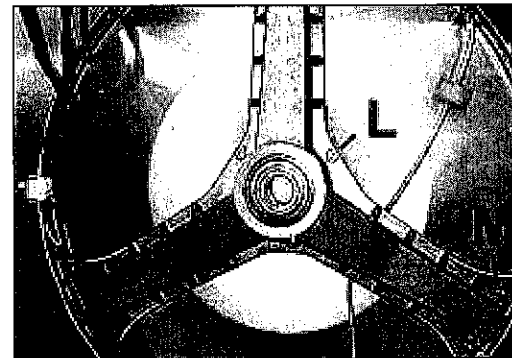

fig. 25

5.2. Changing the ring seal.

- Remove the V-ring from its housing.
- Position tool **X** in the ring seal groove and tighten with the Allen key.
- Protect the shaft with the cover which comes with tool **X**. (fig. 26).
- Tighten the central bolt with a wrench to extract the ring seal.
- Remove the two O rings from inside the ring.

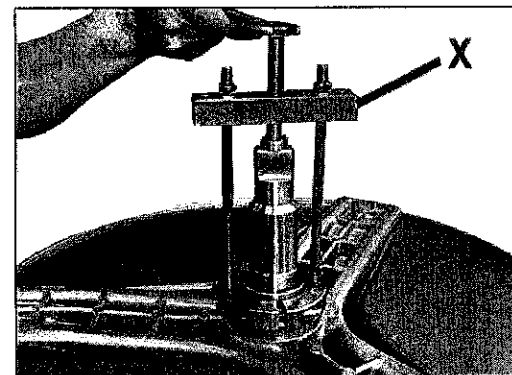

fig. 26

- Fit the two new O rings inside the ring seal. (fig. 27).



fig. 27

- Lubricate the shaft with soapy water and insert the ring seal into the shaft using the Y tool until fully tightened to the drum (fig. 28)

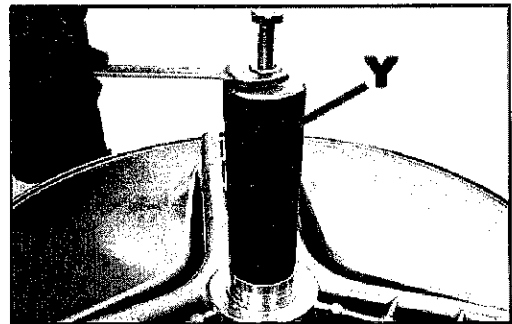

fig. 28

- Place the new V-ring seal on the bottom of the ring seal, pressing lightly with the fingers. (fig. 29).

VERY IMPORTANT!!!

To prevent an incorrect position of the seal lip, strongly press with the fingers the seal lip against the shaft base, immediately before assembling the drum in the bearings box.

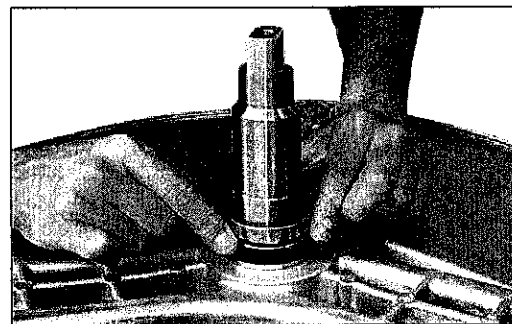

fig. 29

5.3. Assembling the drum.

⚠ IMPORTANT

This operation should be performed with extreme care due to the danger that a blow to the friction area of the seals entails and the following loss of tightness.

- Introduce the end of the drum into the outer drum. Avoid letting the shaft strike or scrape against the back of the outer drum.
- Center the shaft with bearings and introduce it up to the back
- Mount the tool inserter **G** and tighten the locking nut until the drum is firmly fixed. (fig.30).

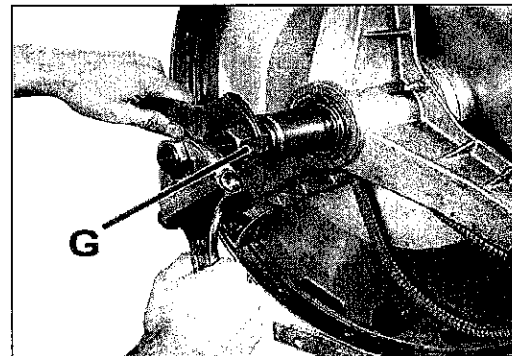

fig. 30

- Mount the pulley and tighten the fastening screw.
- Check that the drum rotates freely.
- Mount the belt. (fig.31).
- Check the pressure transmitter tube isn't damaged and can move freely on the inside of the bearing box leg.

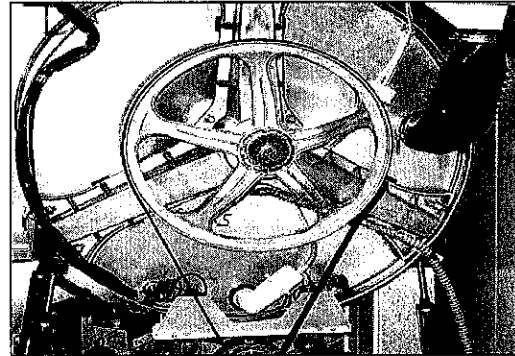

fig.31

5.4. Assembling the front panel of the washing machine.

- Position the front panel against the opening of the outer drum, the arrow point symbol (fig. 32) should signal the welding of the outer drum. Press both pieces until the edges come into contact.

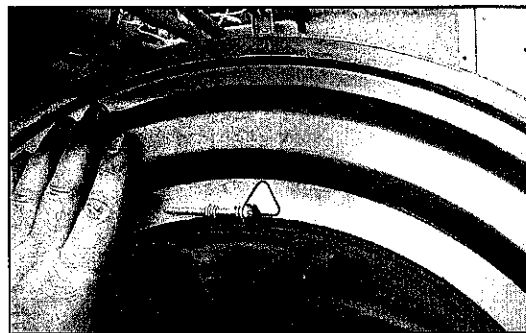

fig.32

- Mount the union gasket. Mount the fastening ring with the ends in the upper part. (be very careful not to damage the unbalance microswitch on the left hand side).
- Tighten the lower area of the ring with the grip pliers (fig. 33). If you have more than one plier, place them in the lower area of the ring.
- Insert the union bolt and lightly tighten
- Tap lightly all the way round the fixing ring with the nylon mallet and tighten the union bolt firmly.

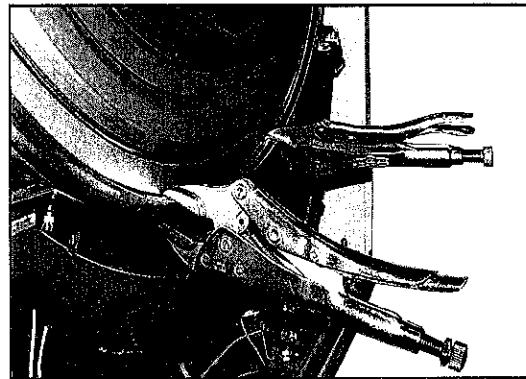

fig.33

5.5. Assembling the covers.

- Match up the front and side panels and fix with the top and bottom screws as indicated by the arrows. (fig. 34).

**IMPORTANT**

Fix the ground wire from the control panel together with the top left screw.

- Fit the door closing and locking mechanism on the front panel. Fix with the screws.
- Check the door catch is correctly lined up and slots in place.
- Place the door seal around the front rim. Fasten in place with the fixing clip.

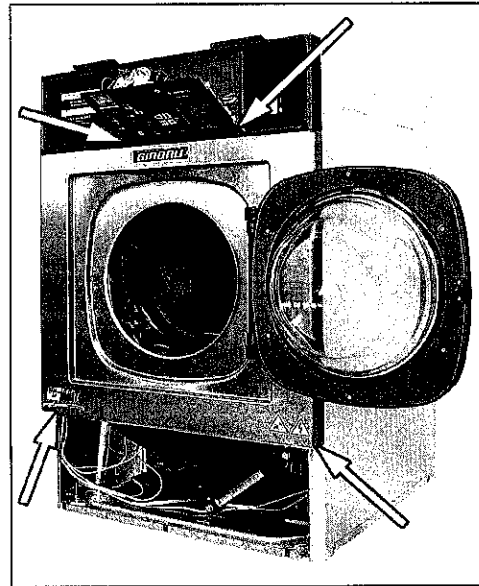

fig.34

- Close the washing machine's control panel using the 22mm wrench (7/8 inch.). (fig. 35).
- Replace the top panel and close with the key supplied with the machine.

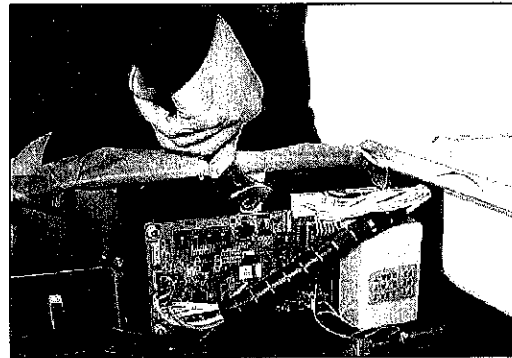

fig.35

- Position the bottom cover panel below the front panel, levering from the bottom upwards with the help of a screwdriver and fix in place with the three screws. (fig.36).

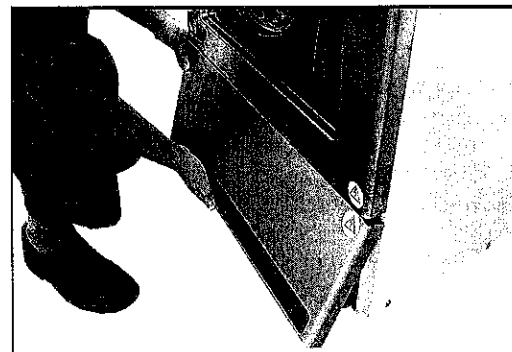

fig.36

- Position the rear cover beneath the rear panel and fix in place with the screws.
(fig. 37).

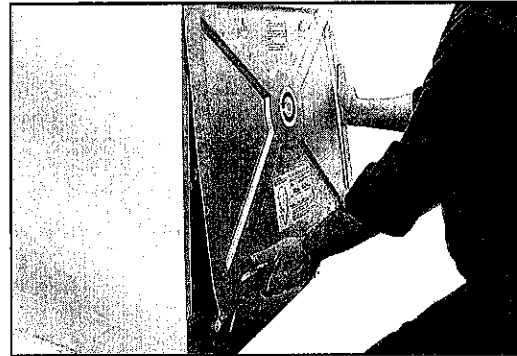

fig. 37

6. FINAL CHECKING

6.1. Checking the machine.

Once **ALL** the washing machine covers are in place and fastened, check the operation and water tightness of the washing machine.



WARNING!!

NEVER START THE MACHINE BEFORE MOUNTING AND FASTENING ALL THE WASHING MACHINE COVERS

Procedure:

Check that the drainpipe outlet is placed and fastened correctly.

Open the manual water supply valves.

Connect the power supply of the washing machine.

Load the washing machine with clothes.

Select a washing program. It is preferable to use a program with high temperature.

Run the selected program. During the execution of the washing cycle, check that no alarms appear, which indicate a malfunction in the machine, especially those related with the inverter, motor...

Once finalized, disconnect the power supply and close the manual valves of the water inlets.

Take the front lower cover and the rear cover off.

Check that the base of the machine is dry and that no bath loss occurs, especially in the joints of the front panel of the outer drum and the door gasket.

Check that no bath loss occurs, especially in the joints of the bearings' box and the back of the outer drum or through the drainage tube.

In the case of not observing any kind of anomaly, put the covers on.

Open the manual valves and connect the power supply.

Remember that:

In LOGI Control machines, there is the possibility of accelerating up the program (see Instruction Manual, section 2.5).

In COIN machines, there is the possibility of using the DEMO program (see Advanced Instruction Manual, section 3.4).